



## What You Will Need

- Color printer
- Heavyweight paper (we suggest 65 lb. paper)
- Cutting tools
- Glue
- Tape
- Note: Cutting intended for grown-ups only



## Instructions

1. Print your pages. Set aside to dry.

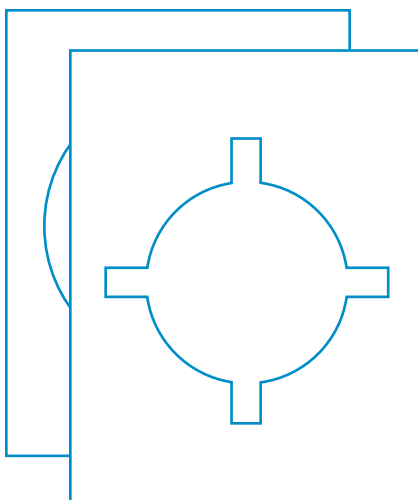

2. Cut out the Hat, Top Rim, Bottom Rim, Hat Cover along the solid lines.

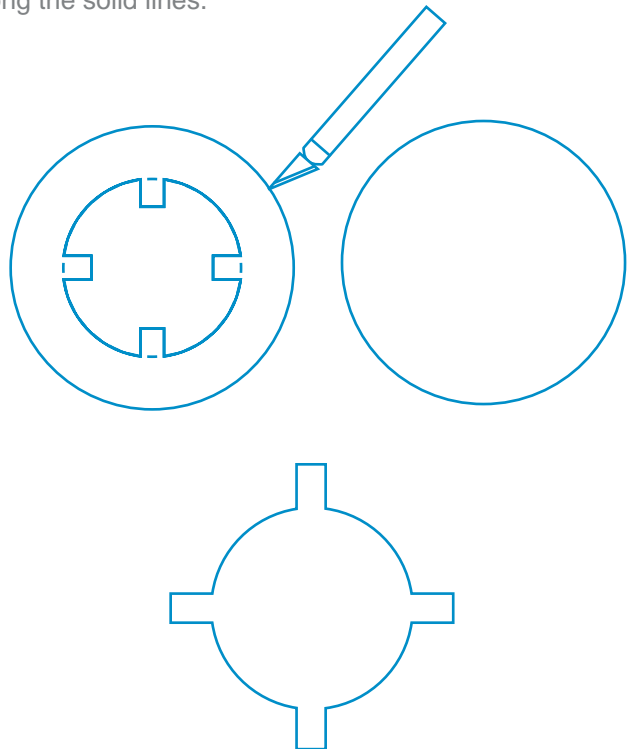



**3.** Glue the Top Rim and Bottom Rim together so that printed sides are facing out. Let dry.

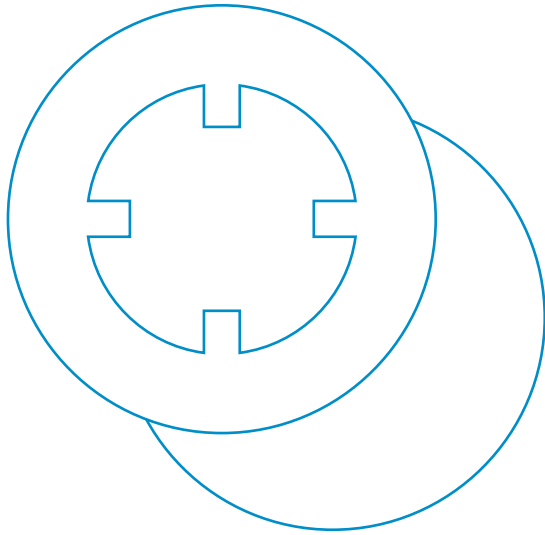

**4.** Cut out the center of the Rim along the solid lines.

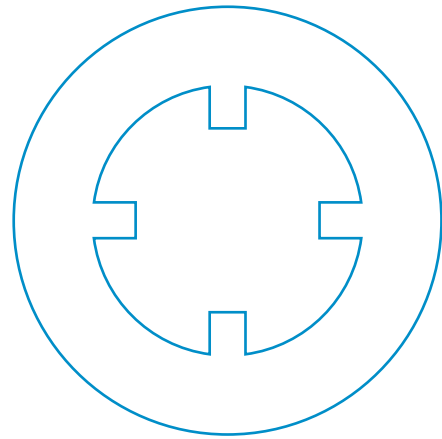

**5.** Crease the flap on the hat. Fold the Hat into a cylinder. Glue the flap to the inside of the Hat.

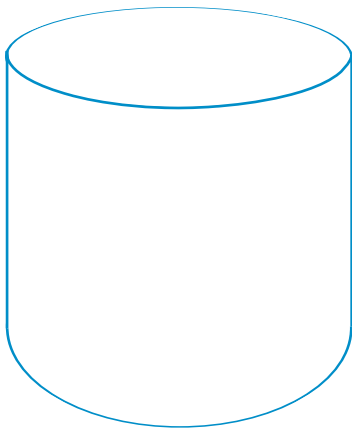

**6.** Crease tabs on the Rim. Apply glue to the tabs on the Rim. Attach the Rim to the cylinder of the Hat.

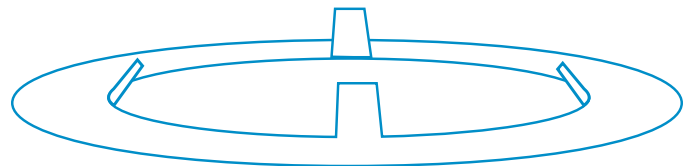



7. Crease tabs on the Hat Cover. Apply glue to the tabs of the Hat Cover. Attach to the cylinder of the Hat.

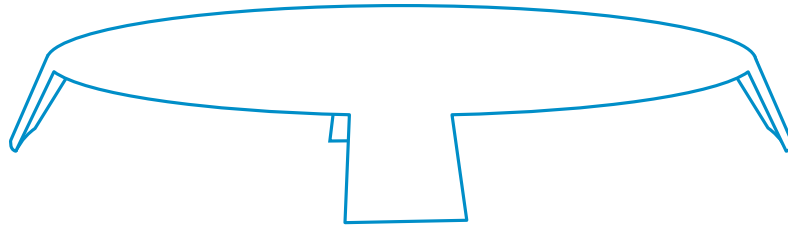

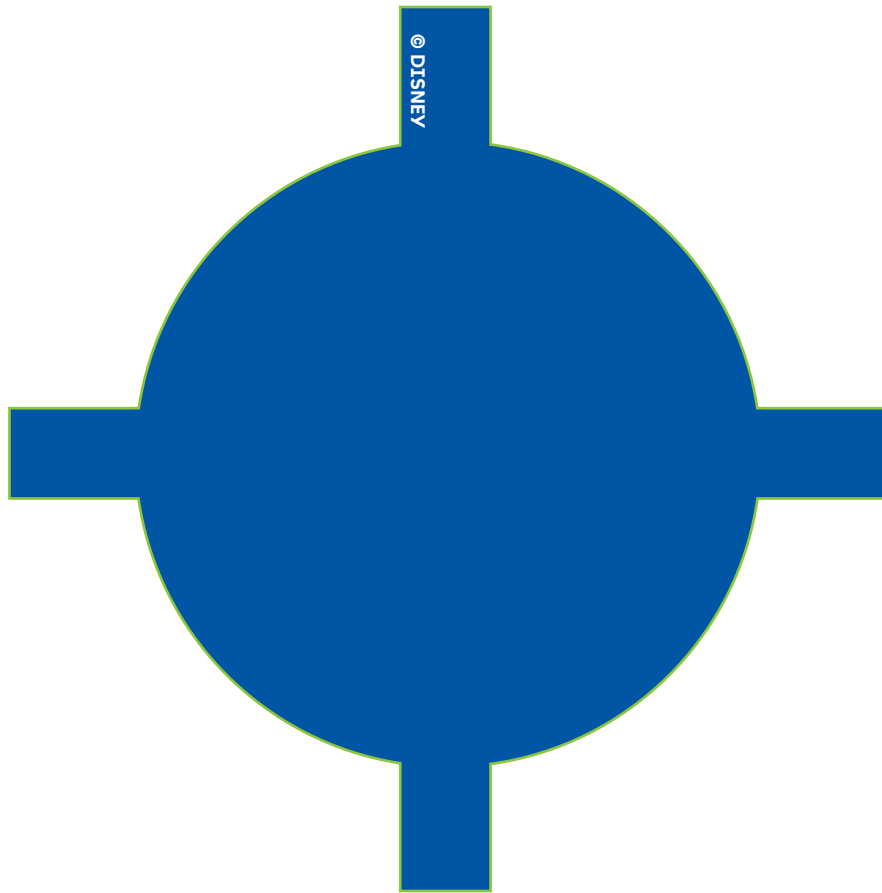



# Mickey Mouse Clubhouse New Year Mickey's Top Hat

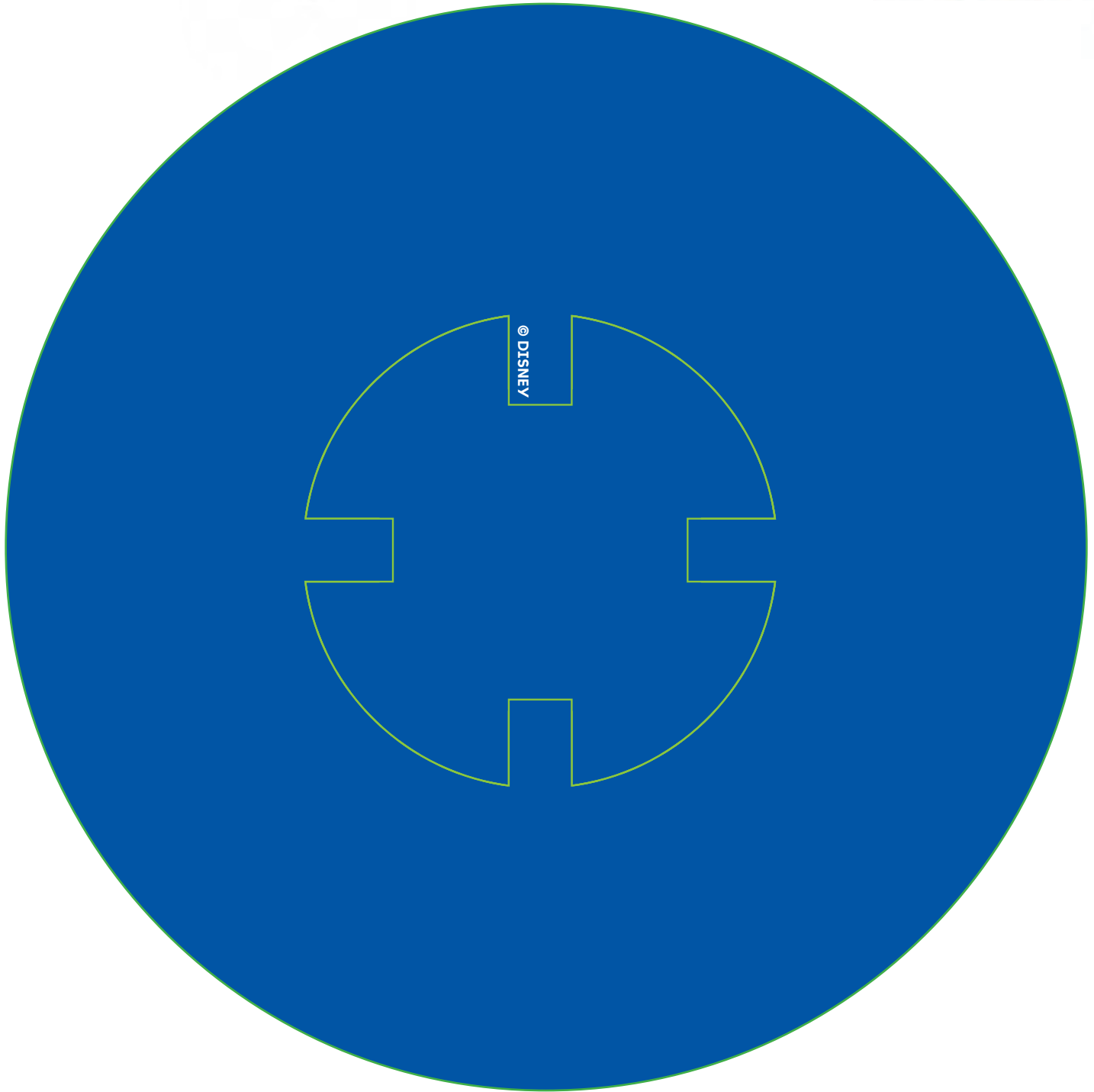



# Mickey Mouse Clubhouse New Year Mickey's Top Hat

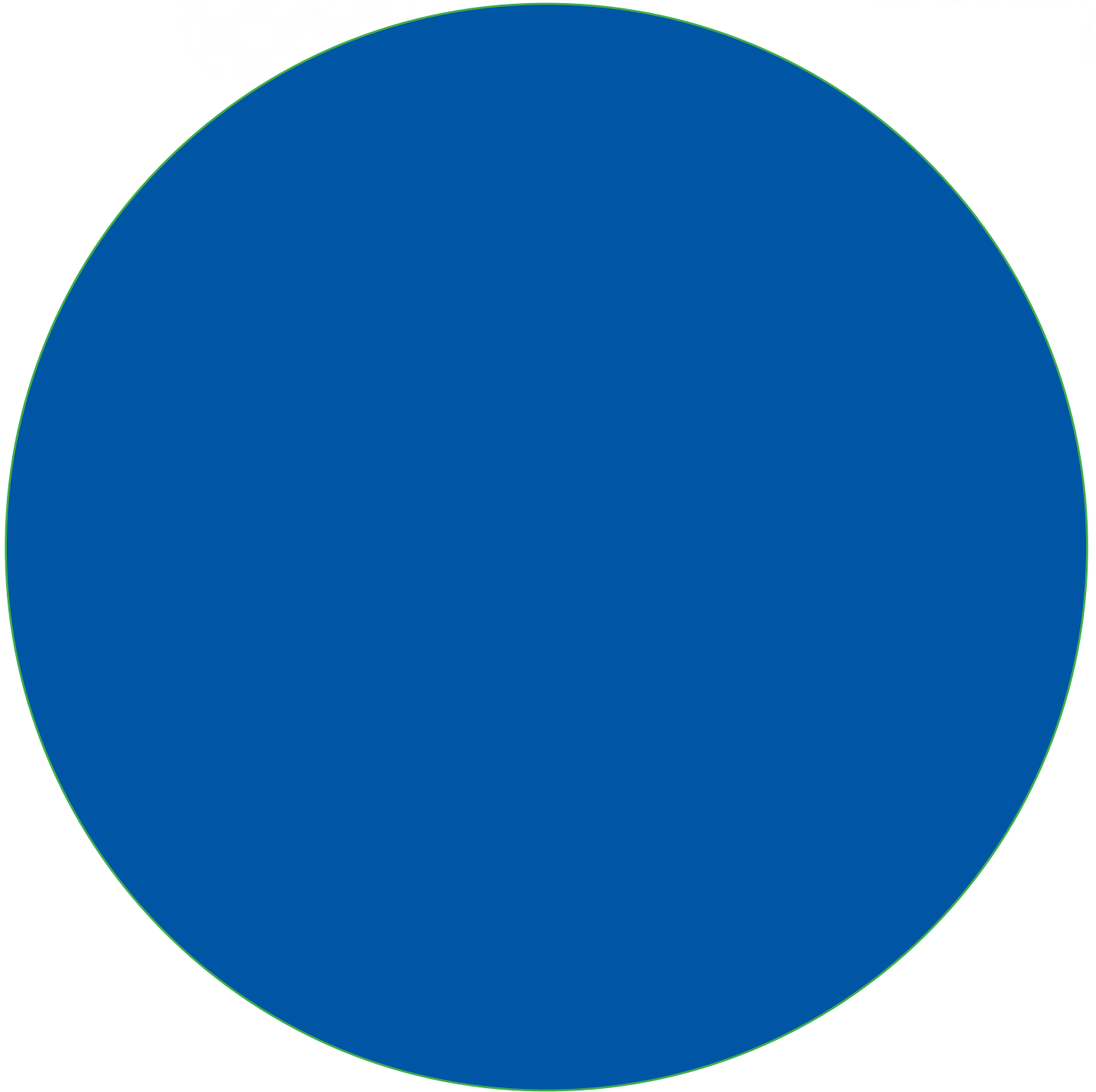

[DisneyJunior.com](http://DisneyJunior.com)





# HAPPY NEW YEAR!



Disney  
MICKY MOUSE  
CLUBHOUSE



## What You Will Need

- Color printer
- Heavyweight paper (we suggest 65 lb. paper)
- Cutting tools
- Double sided tape
- Note: Cutting intended for grown-ups only



## Instructions

1. Print your pages. Set aside to dry.

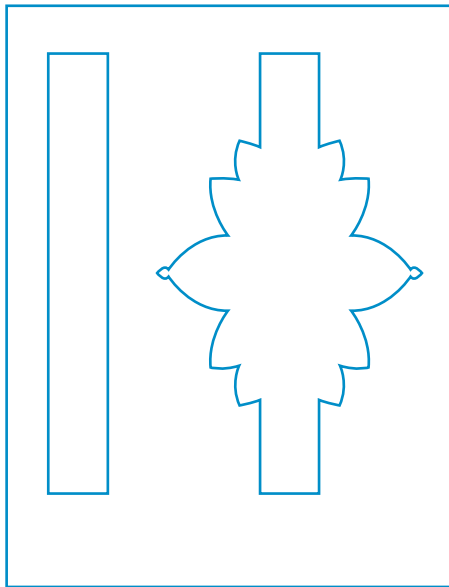

2. Cut out the shape of the tiara. Start along the side of the tiara cutting **ONLY** the solid lines.

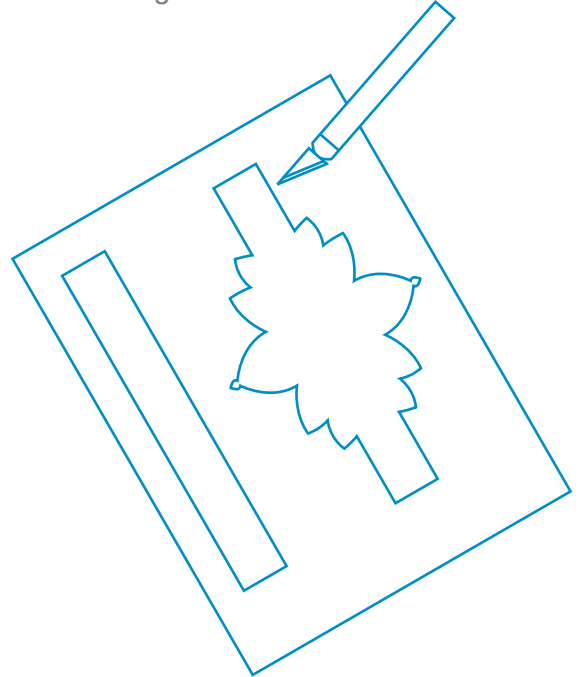





3. Score and fold the tiara and backstrap. Afterwards, apply glue and stick them together.

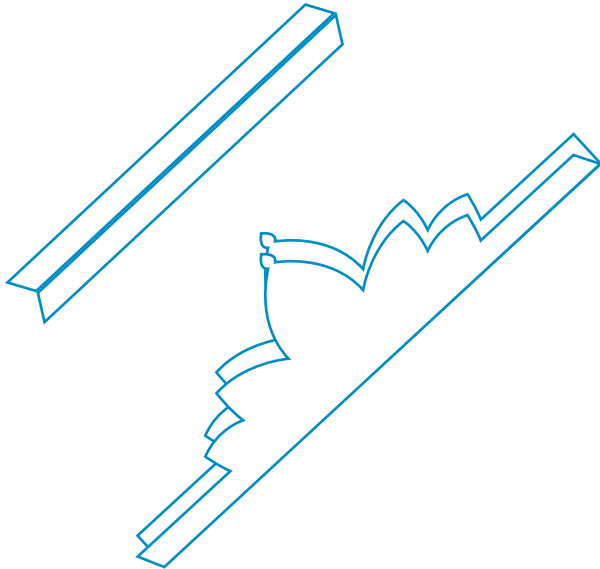

4. Place double sided tape at the edges of the strap and attach to the tiara.

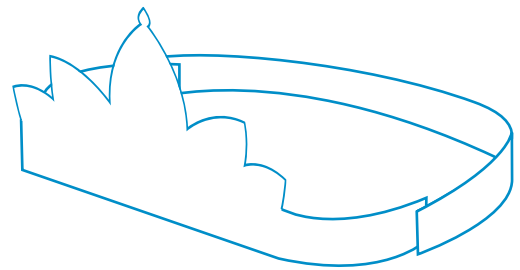

5. Place on your head!

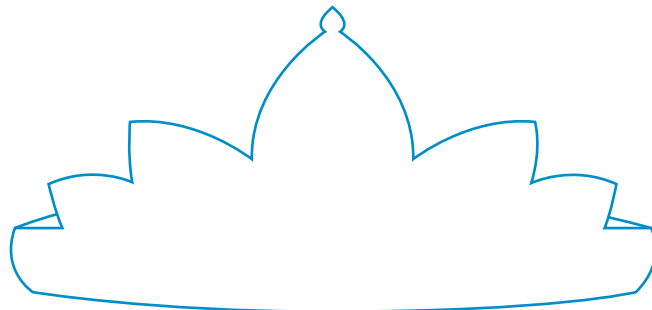

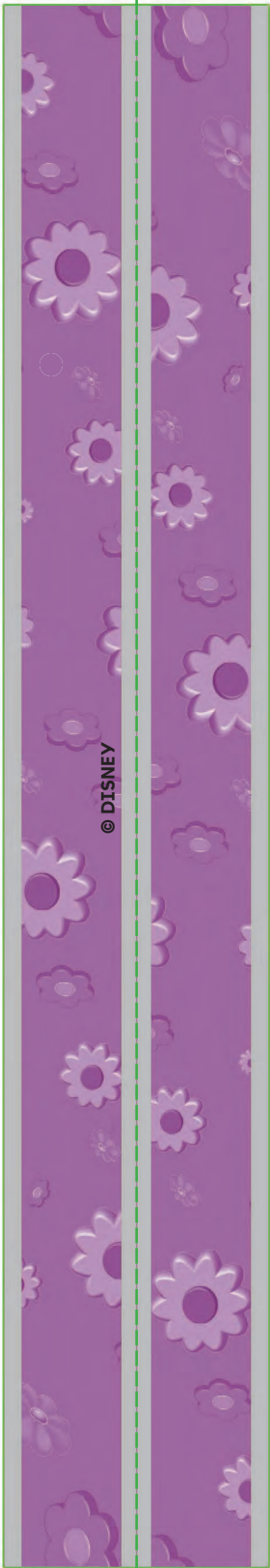

© DISNEY



Disney  
**MICKEY MOUSE CLUBHOUSE**

© DISNEY

**Disney Junior**  
ON DISNEY CHANNEL

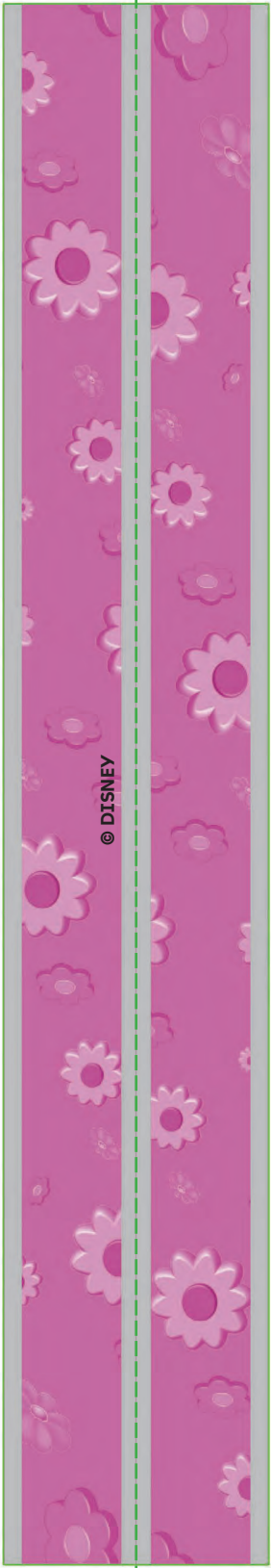





## What You Will Need

- Color printer
- Heavyweight paper (we suggest 65 lb. paper)
- Cutting tools
- Single hole puncher
- Glue
- String or twine
- Note: Cutting intended for grown-ups only



## Instructions

1. Print your pages. Set aside to dry.

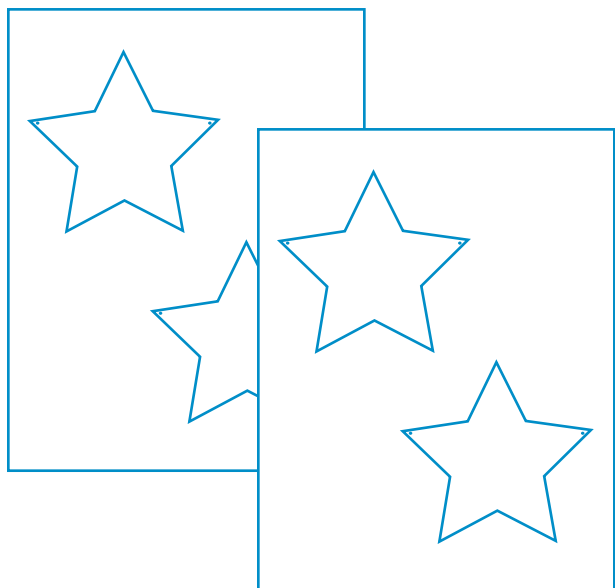

2. Cut out the shape of the star. Start along the side of the star cutting **ONLY** the solid lines. Use a hole puncher to cut out the 2 white holes on each star shape.

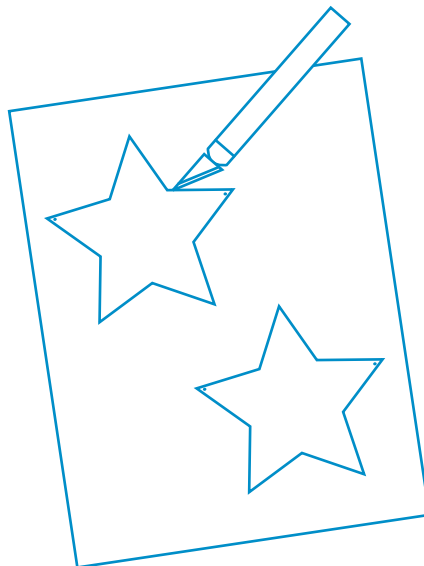



3. Take a piece of string and begin to weave it through the holes at the top of the stars. Be sure to weave from the front of the star through to the back.















© DISNEY



© DISNEY



## What You Will Need

- Color printer
- Heavyweight paper (we suggest 65 lb. paper)
- Cutting tools
- Tape
- String or twine
- Hole puncher
- Note: Cutting intended for grown-ups only



## Instructions

**1.** Print your pages. Set aside to dry.

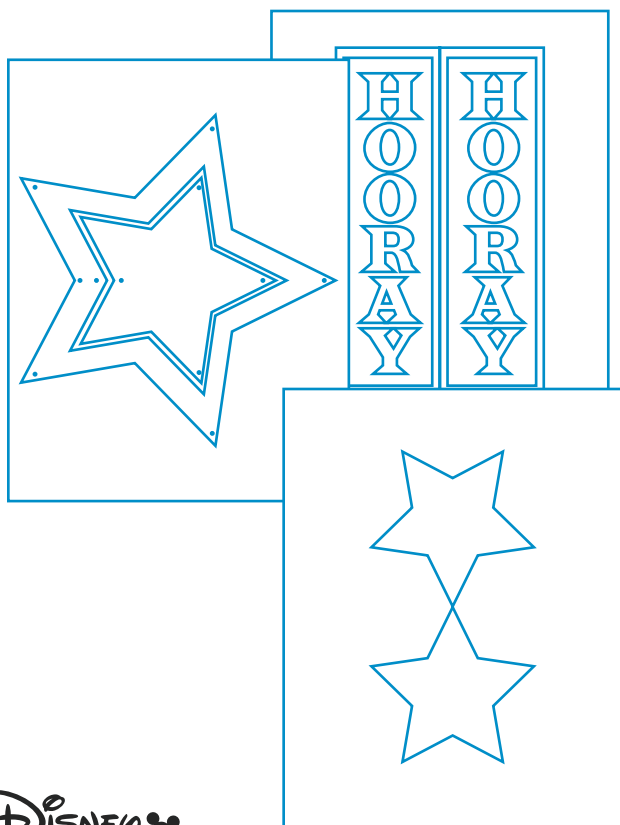

**2.** Cut out the large center stars along the solid lines. Glue the two large stars together so that the printed sides are facing out. Let dry completely. When you are finished you will have two stars, one larger frame star and the inside star that says “Happy New Year!”

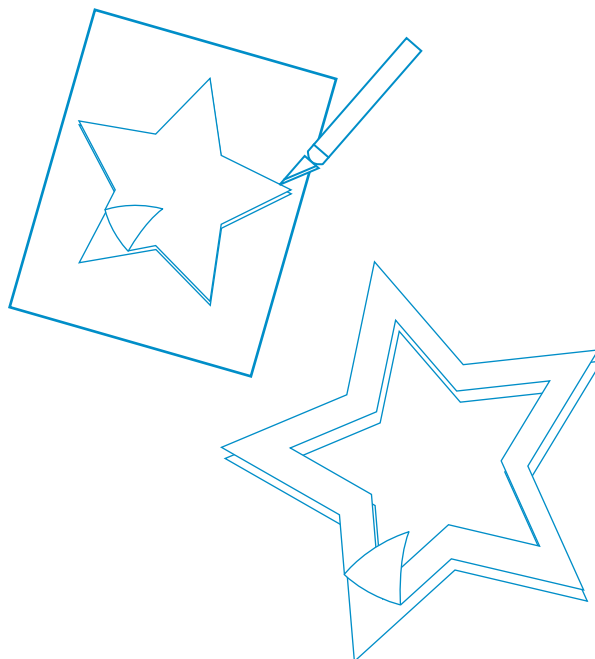





**3.** Cut out the smaller stars and Hooray along the solid lines.

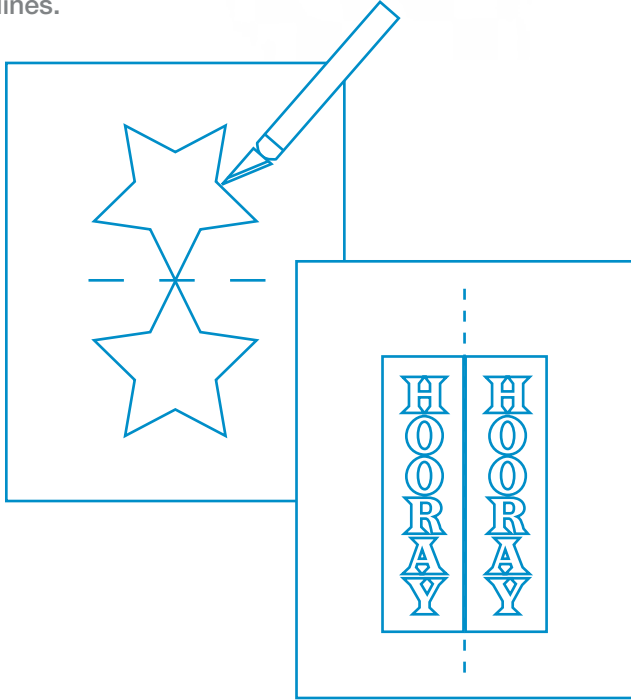

**4.** Fold smaller stars in half along the dotted lines so that both printed sides are facing out. Glue the two sides together.

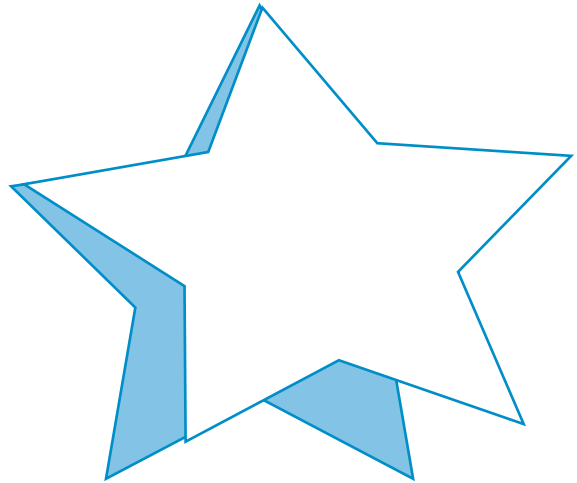

**5.** Glue the two halves together. Once dry, cut out the white space, leaving you with the dark blue frame and the inside "Hooray" box.

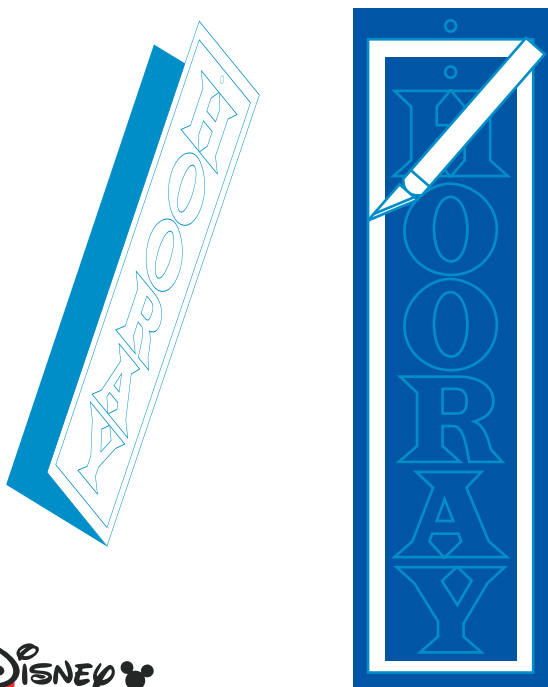

**6.** Use a hole puncher to cut out the white holes on all the stars and the top of the Hooray piece.

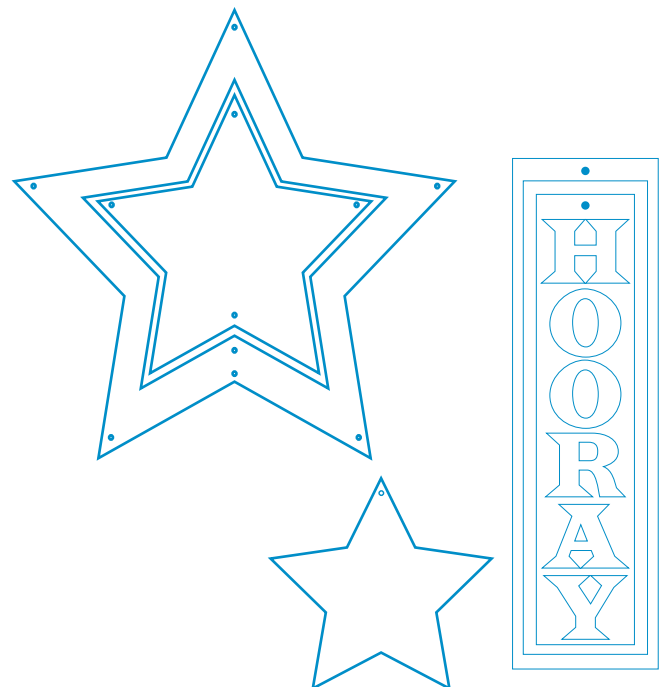



**7.** Cut string or twine into the following:

- 1 piece of 2" string
- 2 pieces of 5.5" string
- 4 pieces of 6.5" string
- 1 piece of 8" string
- 1 piece of 11" string

**8.** To thread the two main stars together, take the 2" piece of string and thread through the top two holes shown here. Tape at both ends with clear tape.

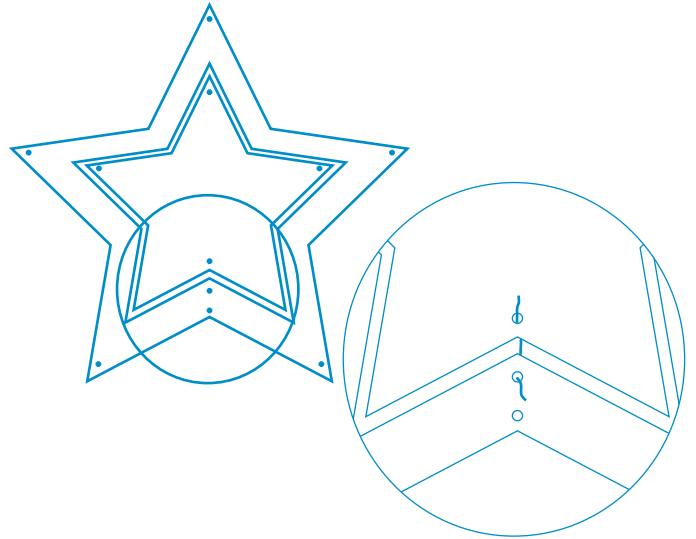

**9.** Take the 8" piece of string and thread through the two holes shown here. Tape the string to the bottom hole with clear tape. Leave the extra string at the top to hang from the ceiling.

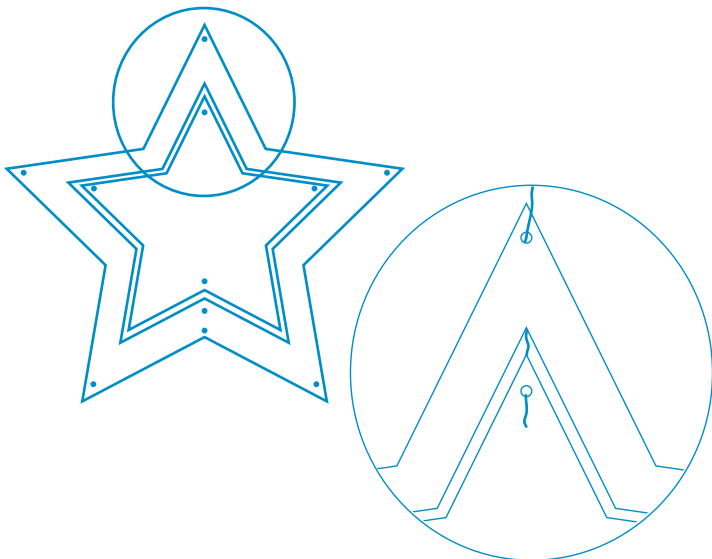

**10.** Take the four pieces of 6.5" string and thread through the holes on the smaller stars with Mickey, Donald, Goofy, and Pluto. Tape the string with clear tape. Take the two pieces of 5.5" string and thread through the holes on the smaller stars with Minnie and Daisy. Tape the string with clear tape.

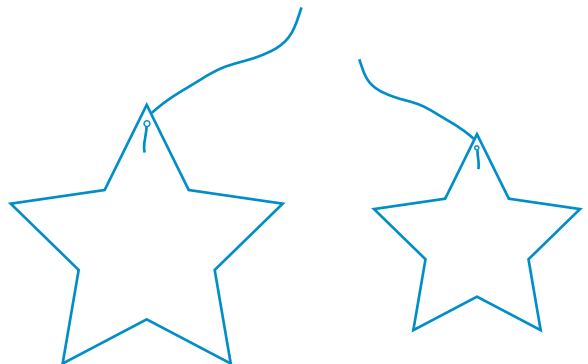



**11.** Take the piece of 11" string and thread through the hole on the Hooray piece. Tape the string with clear tape.

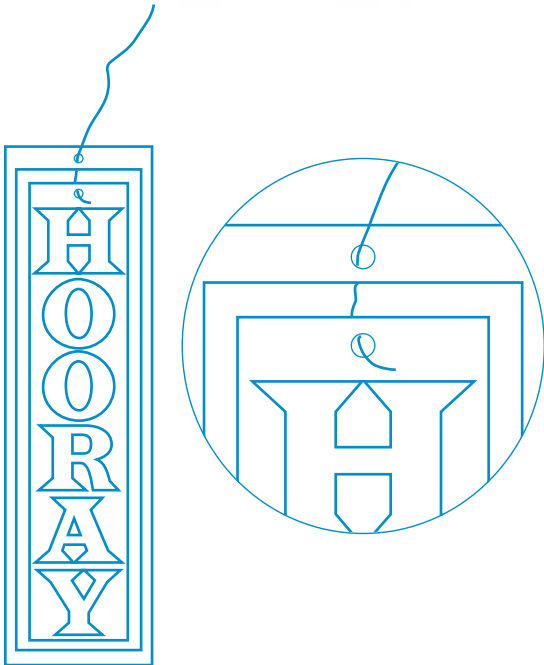

**12.** Take the Mickey and Donald stars and thread through the holes as shown below.

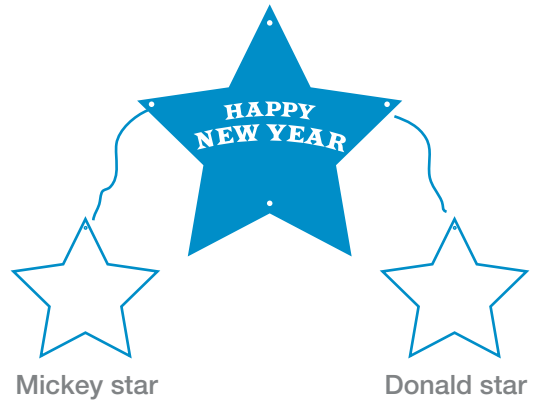

**13.** Take the Minnie, Daisy, Goofy, and Pluto stars and thread through the holes as shown below. Take the piece of 11" string and thread through the holes on the Hooray piece. Tape the string with clear tape. Now that the New Year's Hanging Mobile Centerpiece is all put together, hang over your main seating and/or buffet table.

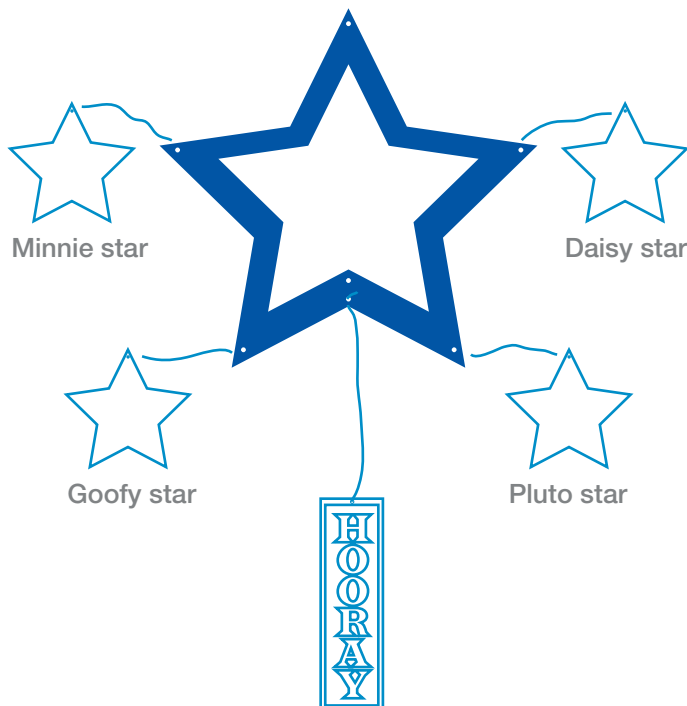



# Mickey Mouse Clubhouse New Year Mobile Centerpiece

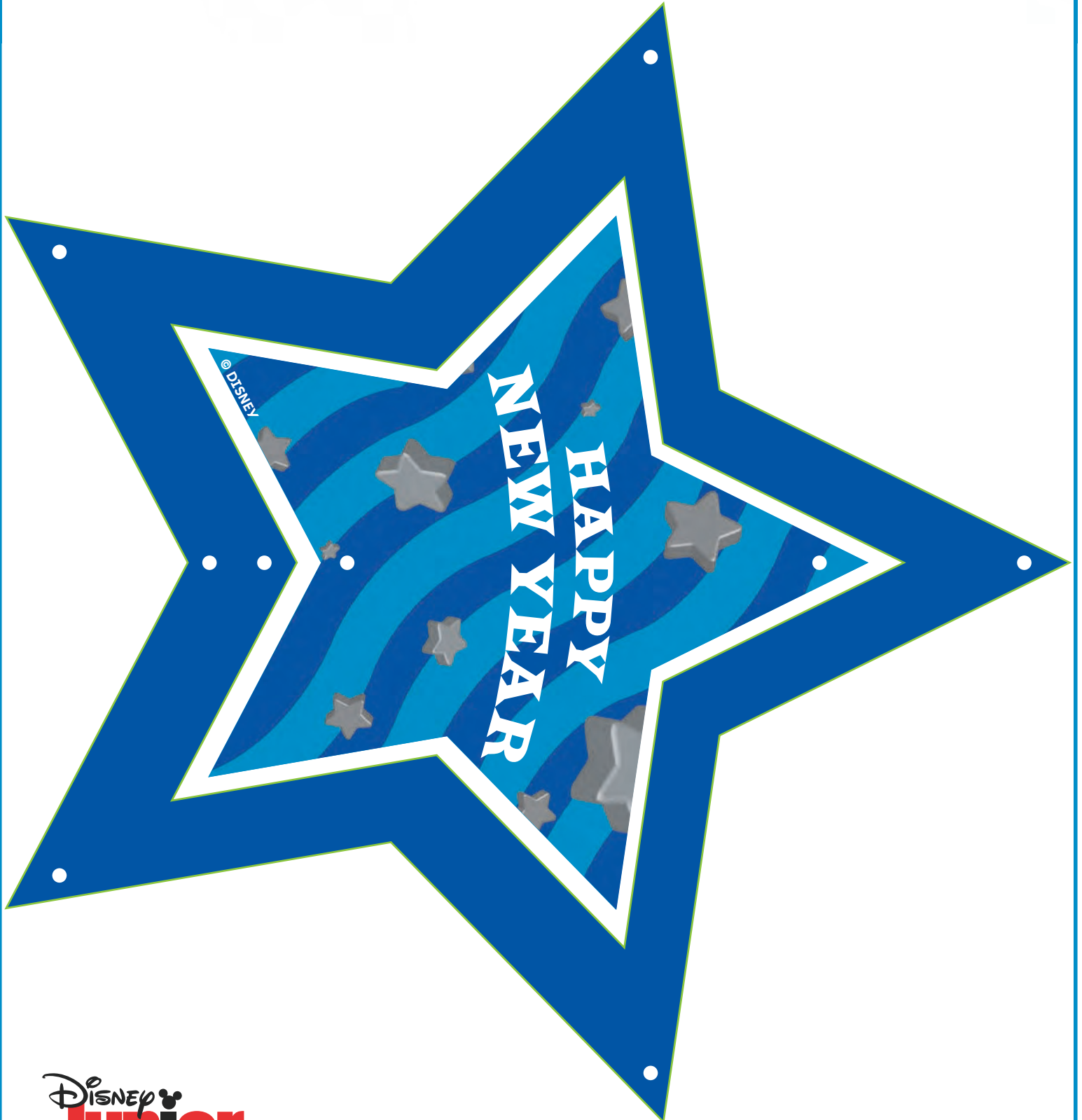





# Mickey Mouse Clubhouse New Year Mobile Centerpiece

























## What You Will Need

- Color printer
- Inkjet/laser Vellum paper
- Cutting tools
- Glue and double sided tape
- Straws
- Note: Cutting intended for grown-ups only



## Instructions

1. Print your pages. Set aside to dry.

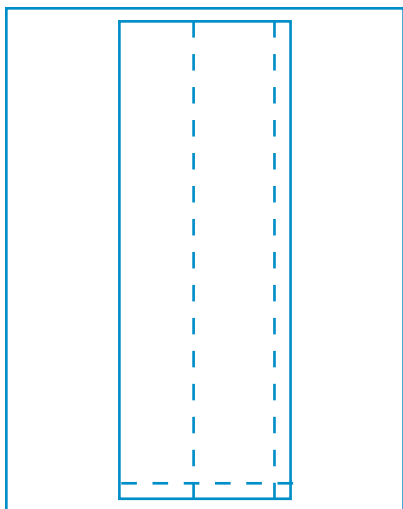

2. Cut out the shape of the party blower. Start along the side of the rectangle cutting **ONLY** the solid lines.

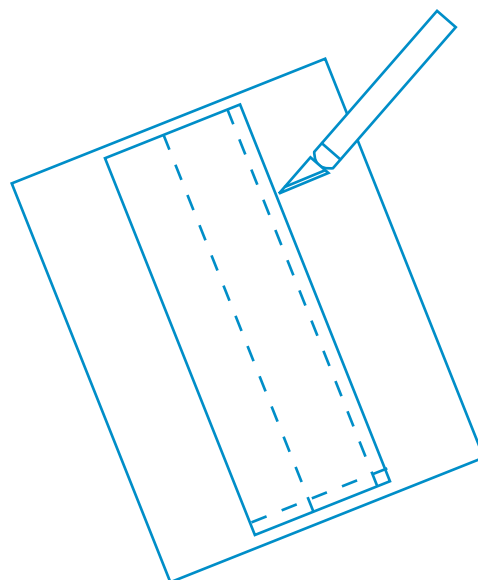



3. Score and fold where along the dotted lines.

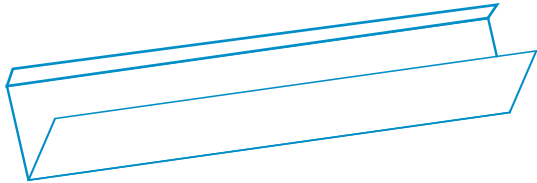

4. Apply glue to the smaller tab and glue the party blower together.



5. Score and fold the edge of the party blower then glue together. Allow to dry.

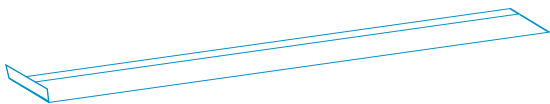

6. Use a pen or straw as a guide to roll the party blower up. Afterwards, wrap with a rubberband and allow to sit for one day before removing.

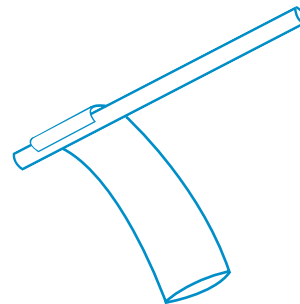





7. Apply double sided tape to the straw then Insert the straw into the opening of the party blower.

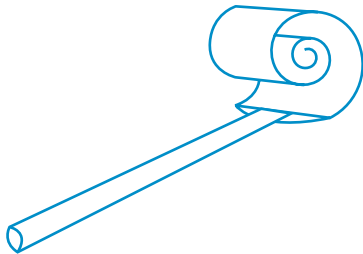

8. Fold the left edge followed by the right edge and to seal the straw in.

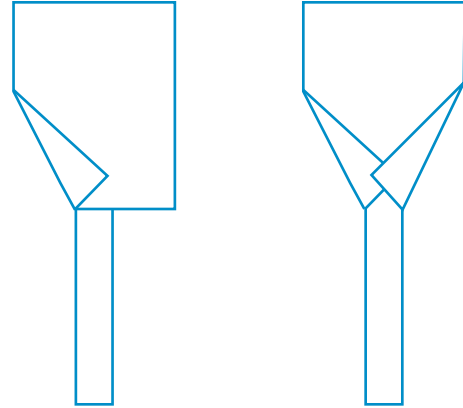

9. Allow to dry. Once the party blower has dried, start blowing!

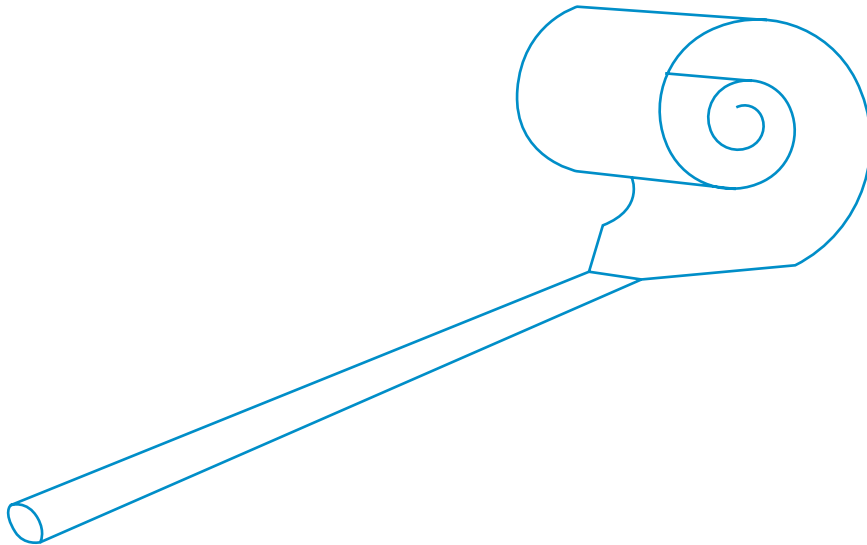



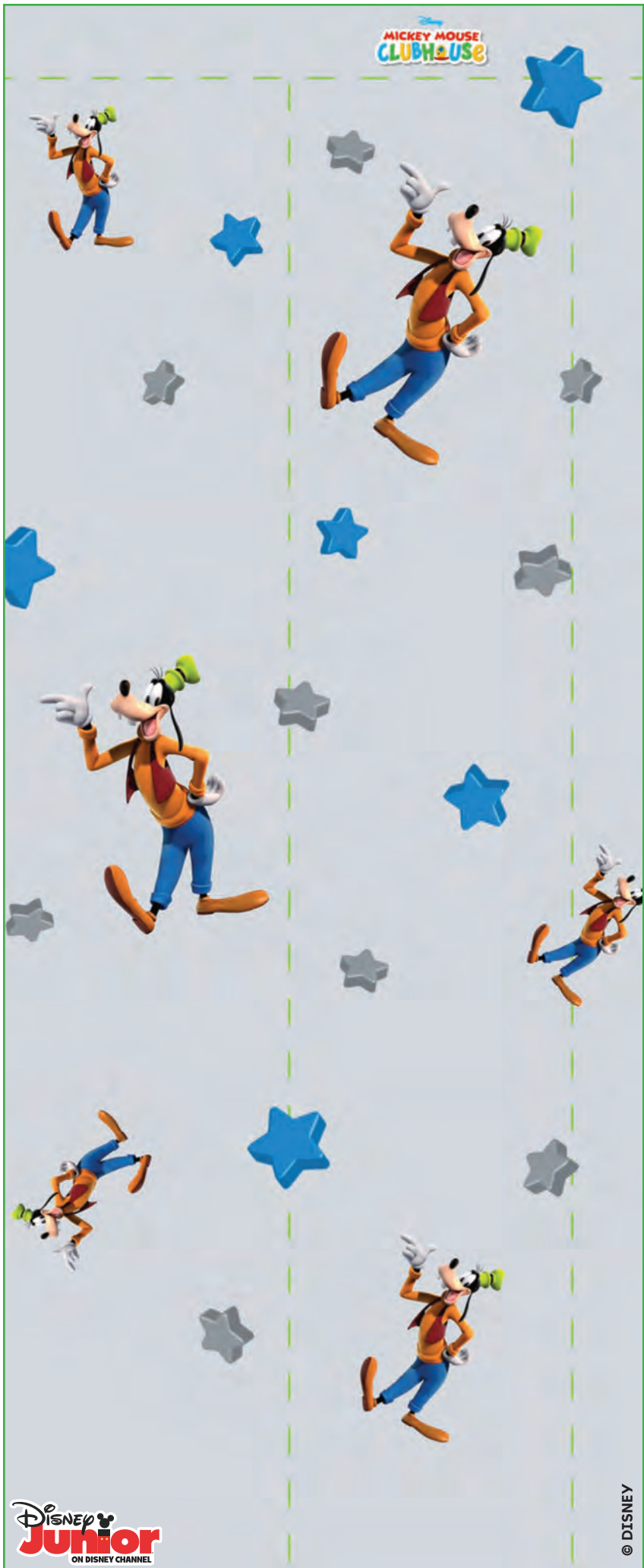







## What You Will Need

- Color printer
- Heavyweight paper (we suggest 65 lb. paper)
- Cutting tools
- Glue
- Confetti
- Paper towel tubes
- Tissue paper
- Ribbon
- Note: Cutting intended for grown-ups only



## Instructions

1. Print your pages. Set aside to dry.

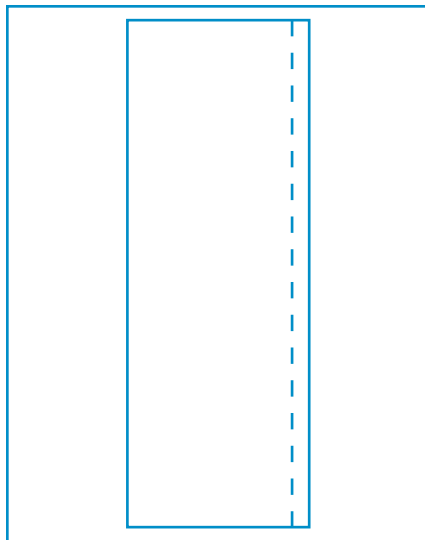

2. Cut out the Confetti Tube wrapper. Start along the side of the rectangle cutting **ONLY** the solid lines.

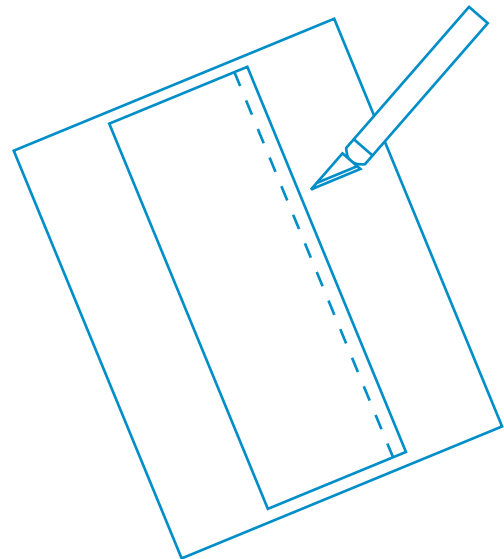



**3.** Put glue on the back side of the paper towel tube printout and wrap onto the empty paper towel tube.

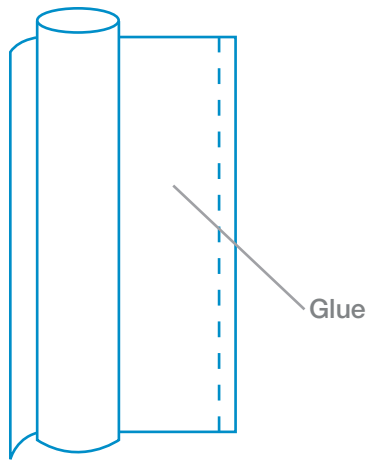

**4.** Cover the top of the Confetti Tube with the tissue paper and tie a bow with the ribbon.

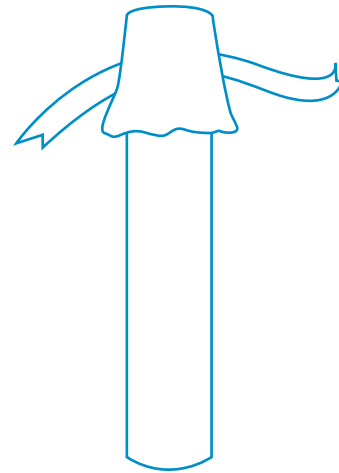

**5.** Fill the paper towel tube with confetti.

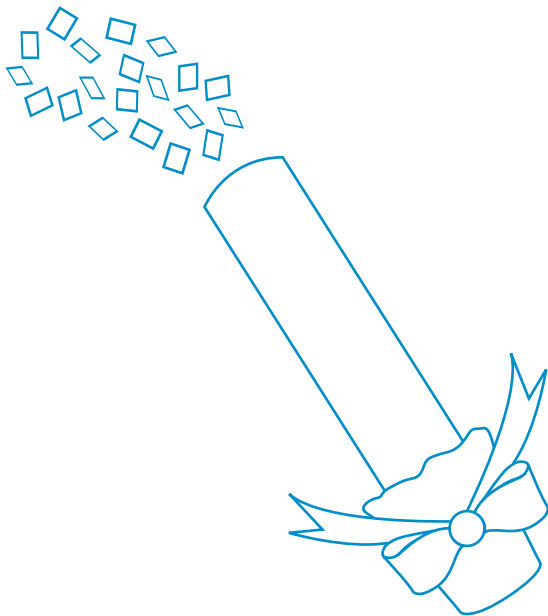

**6.** Cover the other end of the tube with tissue paper and tie with ribbon to prevent the confetti from falling out.

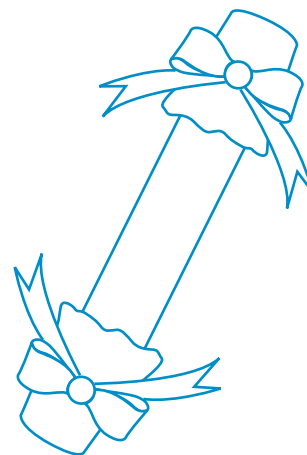

# HAPPY NEW YEAR!

