

Kwanzaa Pride Blocks



MATERIALS

- Scissors or cutting tool
- Multi-purpose glue
- Metal-edged ruler
- Butter knife
- Cutting mat (optional)

INSTRUCTIONS **NOTE:** Project assembly is intended for grown-ups only.

- 1** Print out pages. Allow to dry.

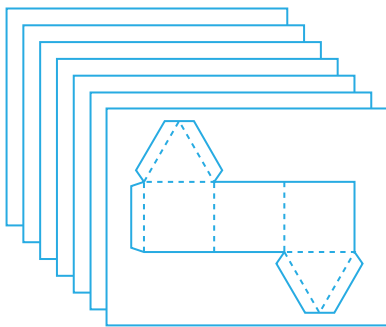

- 2** Using scissors or a cutting tool and cutting mat, cut along solid lines on each piece.

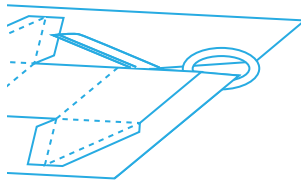

- 3** Using a ruler as a guide, run the backside of a butter knife firmly along dotted lines on all pieces.



- 4** Fold the vertical flap on the left side of the first panel and glue it to the inside of the third panel so that it forms a triangle.

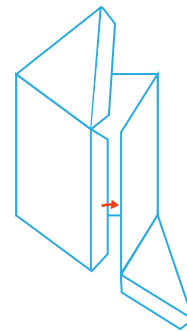

- 5** Fold the flaps down on the triangular top and bottom. Glue the flaps to the inside of the triangular body.

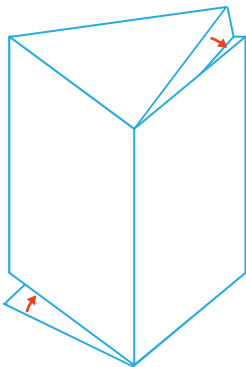

- 6** Allow to dry. Repeat steps 1–5 for the remaining pride blocks.

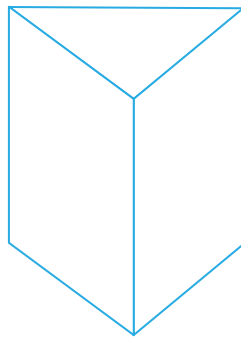

THE KWANZAA PRINCIPLES ARE:

UMOJA (oo-MOH-JAH) – Unity

To strive for and maintain unity in the family, community, nation, race.

KUJICHAGULIA (koo-jee-chah-goo-LEE-ah) – Self-determination

To define ourselves instead of being defined by others.

UJIMA (oo-JEE-mah) – Collective work and responsibility

To build and maintain our community together and solve problems together.

UJAMA A (oo-jah-MAH) – Cooperative economics

To build and maintain the stores and businesses in our community and to profit from them together.

NIA (NEE-ah) – Purpose

To build and develop our community to restore our people

KUUMBA (koo-OO-mbah) – Creativity

To do always as much as we can, in the way we can, in order to leave our community more beautiful and beneficial than we inherited it.

IMANI (ee-MAH-nee) – Faith

To believe with all our heart in our people, our parents, our teachers, our leaders and the righteousness and victory of our struggle.



DisneyJunior.com

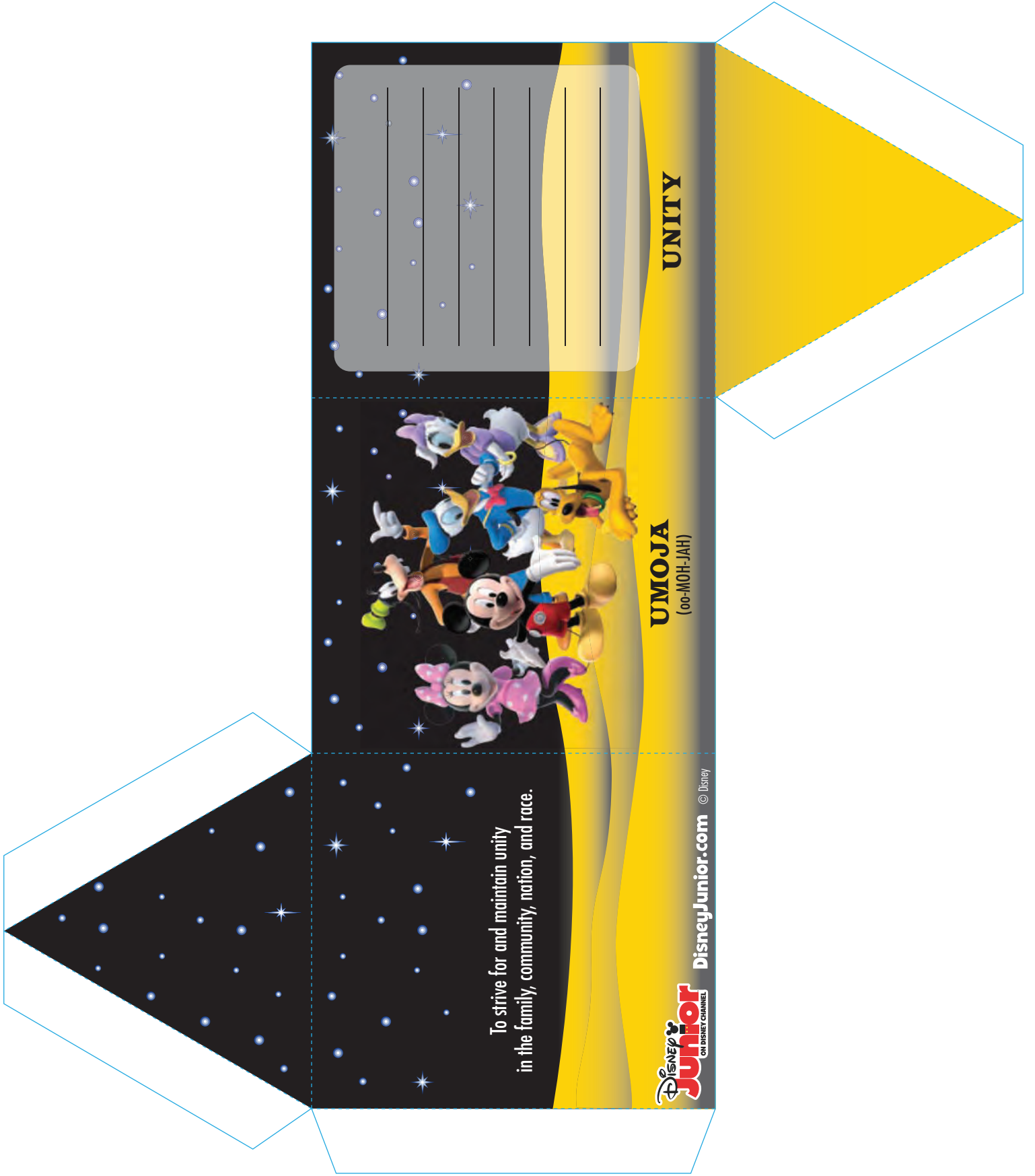

To strive for and maintain unity
in the family, community, nation, and race.



DisneyJunior.com © Disney

UMOJA
(OO-MOH-JAH)

UNITY

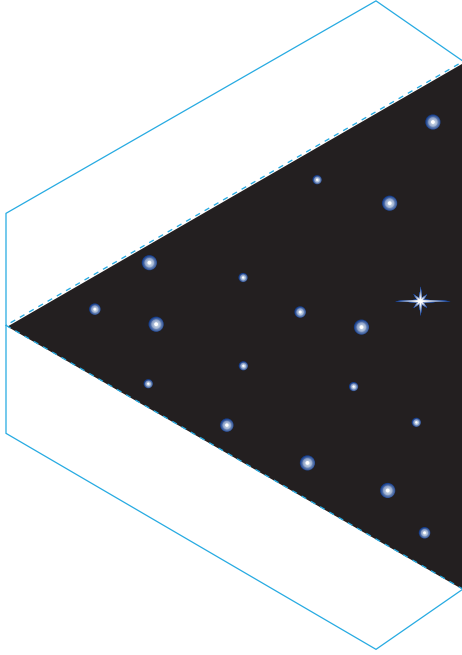

To define ourselves instead
of being defined by others.

KUJICHAGULIA
(koo-ji-chaht-goo-LEE-ah)

SELF-DETERMINATION



DisneyJunior.com © Disney

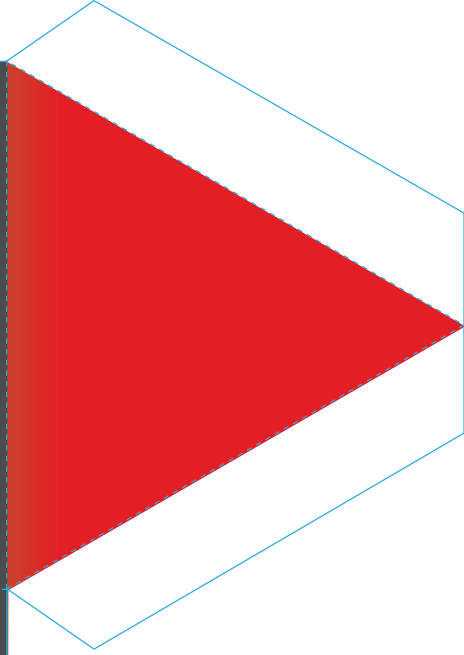

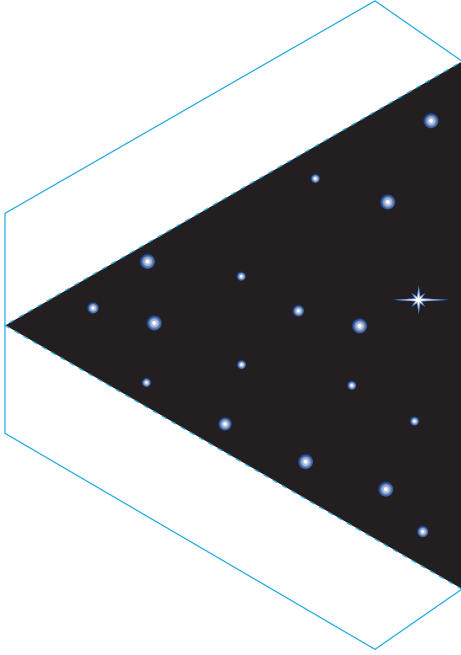

To do always as much as we can,
in the way we can, in order to leave
our community more beautiful and
beneficial than we inherited it.



DisneyJunior.com © Disney

KUUMBA
(koo-00-mbah)

CREATIVITY

A grey rectangular box with horizontal red lines and small blue stars, intended for writing.

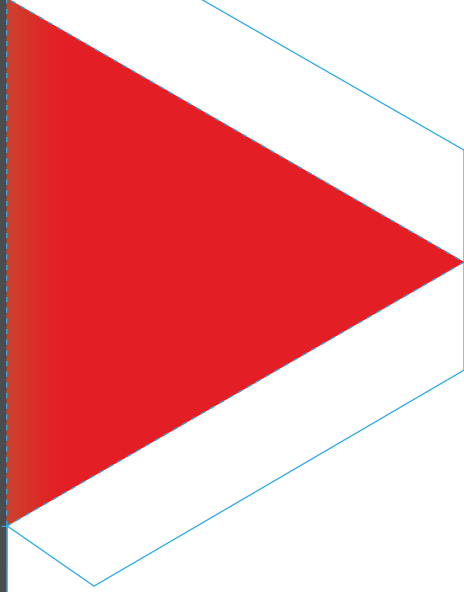

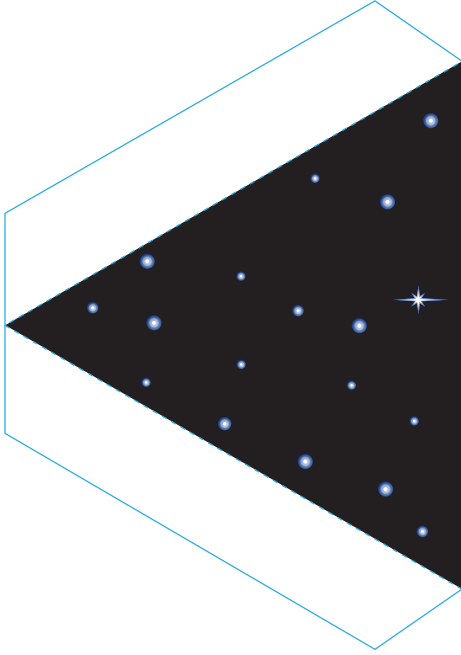

To build and maintain the stores
and businesses in our community
and to profit from them together.

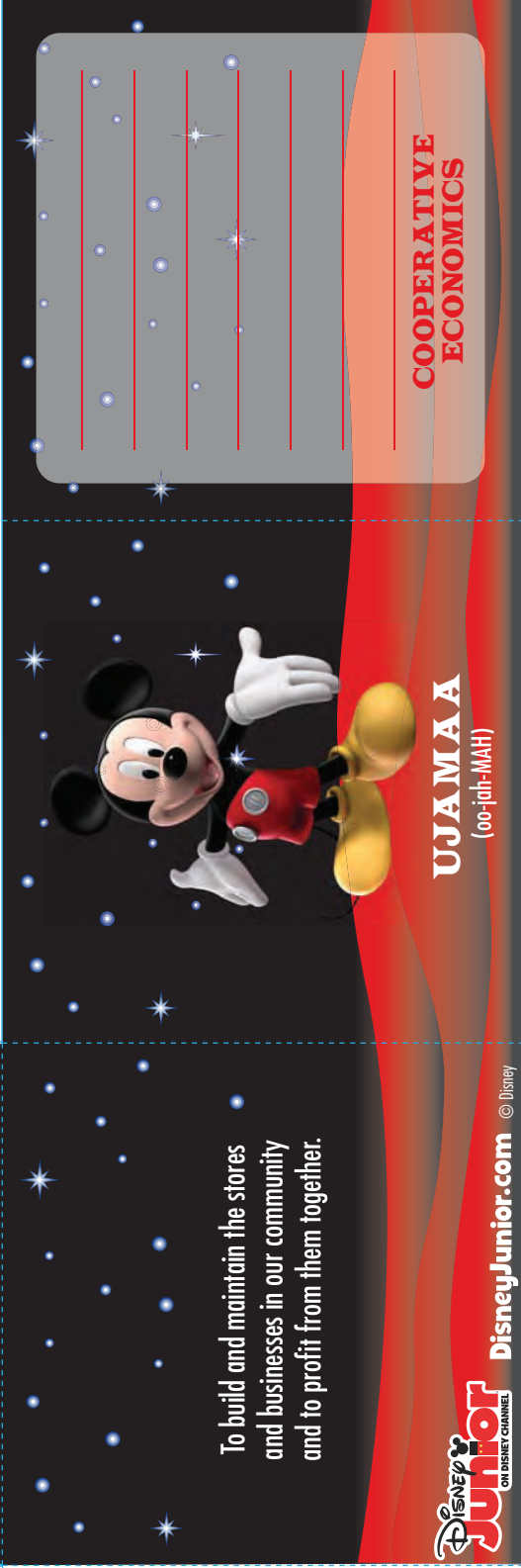

DisneyJunior.com © Disney

UJAMAA
(oo-jah-MAH)

**COOPERATIVE
ECONOMICS**

Handwriting practice area with six horizontal lines and decorative stars and dots.

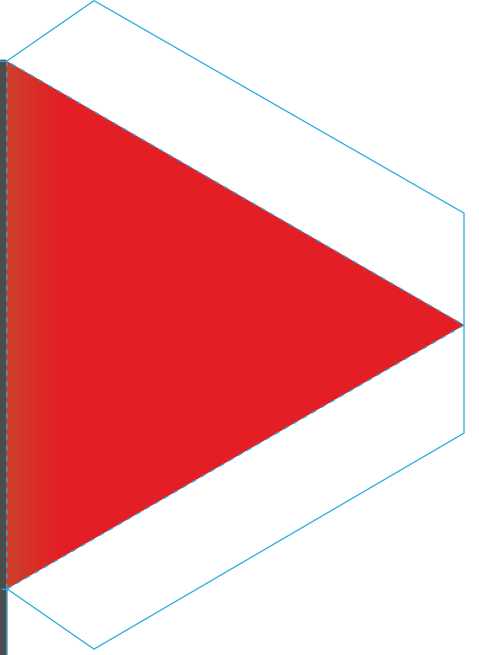

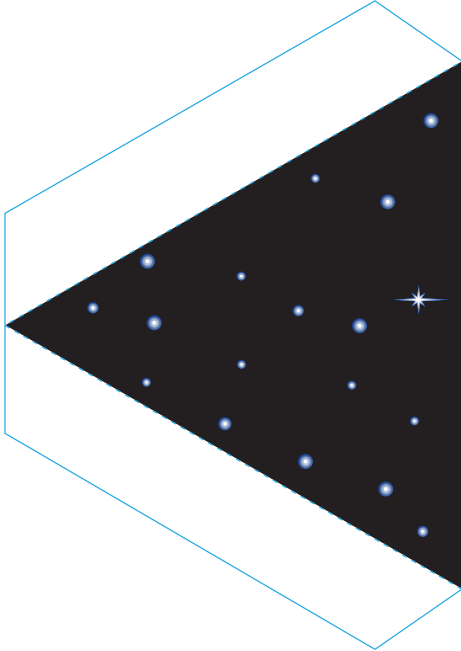

To build and maintain our community
together and solve problems together.



DisneyJunior.com © Disney

UJJIMA
(oo-JEE-mah)

A rectangular area with a light gray background and a dark gray border. It contains several horizontal lines for writing, interspersed with small white starburst icons. The background of this area also features a pattern of small white stars.

**COLLECTIVE WORK
AND RESPONSIBILITY**

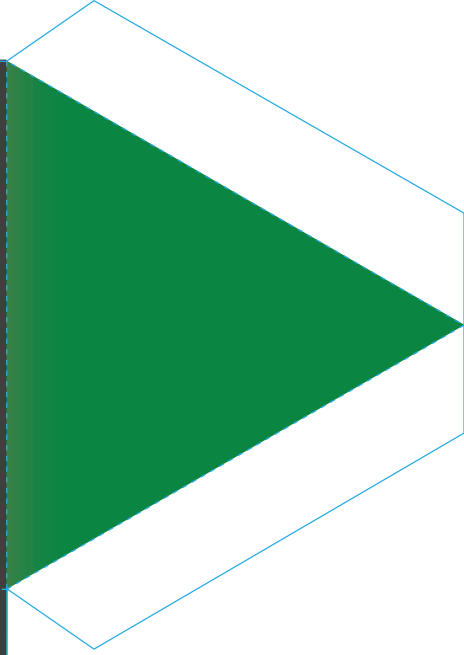

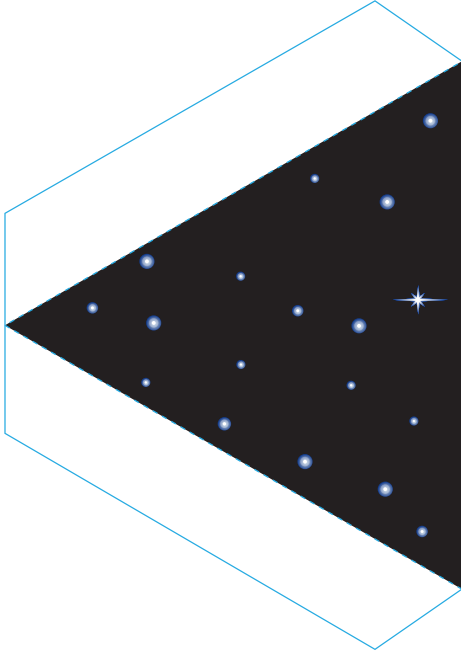

To build and develop our community
to restore our people to their
traditional greatness.



PURPOSE

A grey rectangular area containing several horizontal lines for writing, with small blue star icons scattered throughout.

Disney Junior
ON DISNEY CHANNEL
DisneyJunior.com © Disney

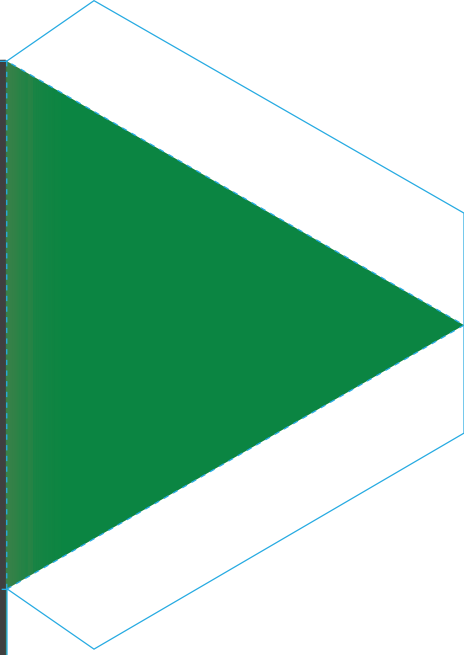

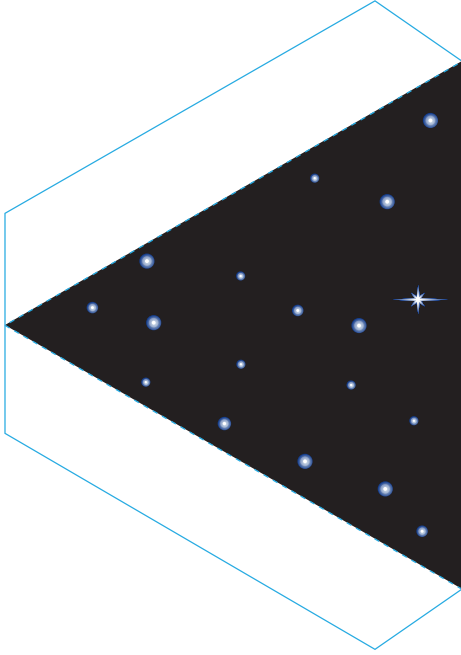

To believe with all our people, our parents,
our teachers, our leaders and the
righteousness and victory of our struggle.



DisneyJunior.com © Disney

IMANI
(ee-MAH-nee)

A grey rectangular box with a decorative border of small blue circles and white stars. Inside the box are several horizontal green lines for writing, with a larger blank space at the bottom.

FAITH

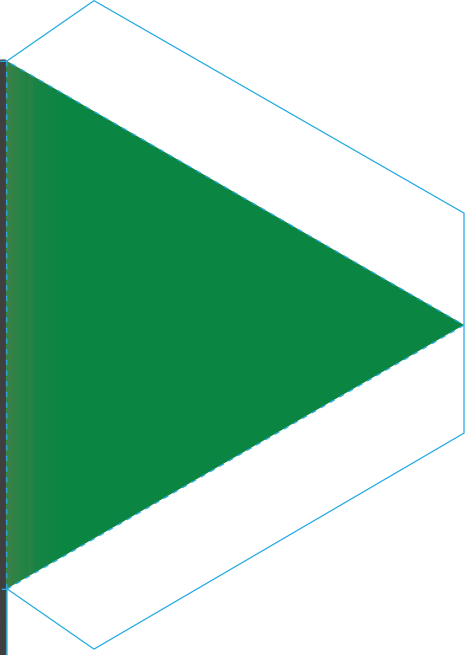

Kwanzaa Drum



MATERIALS

- Empty oatmeal container (18 oz.)
- Scissors or cutting tool
- Multi-purpose glue
- Cutting mat (optional)

INSTRUCTIONS **NOTE: Project assembly is intended for grown-ups only.**

- 1** Print out pages. Allow to dry.

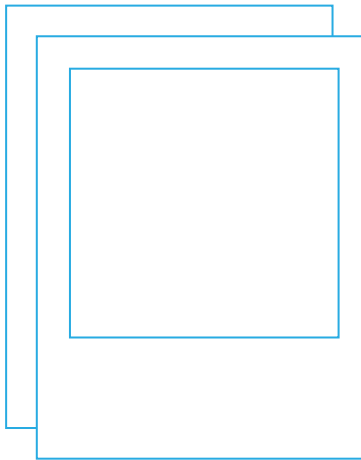

- 2** Using scissors or a cutting tool and cutting mat, cut along solid lines on each piece.

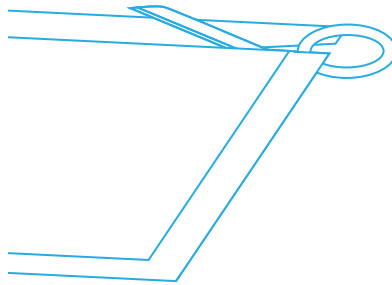

- 3** Wrap and glue elements around drum as shown.

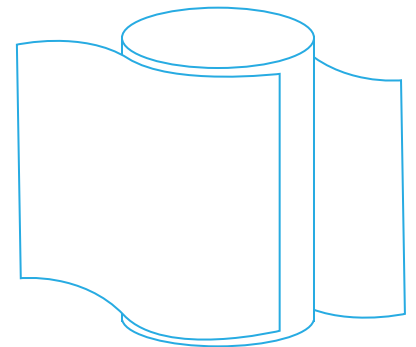

- 4** Allow to dry.

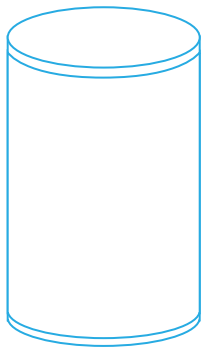

Drums are an important part of the Kwanzaa celebration. In fact, there are some who think that the voices of one's ancestors speak through the drums!

Drums are a great way to bring the principles of Kwanzaa alive, by holding the rhythm, playing together with one another in time, and showing unity: the first principle of Kwanzaa.

Try playing your Kwanzaa drum with friends, your kids and the rest of the family.

During the Karamu feast, drums are played as the names of ancestors and African-American heroes are called. This is also when the feast begins and more songs and dances are performed.





DisneyJunior.com

©Disney



DisneyJunior.com

3-D Kwanzaa Picture Frame



MATERIALS

- Scissors or cutting tool
- Multi-purpose glue
- Metal-edged ruler
- Butter knife
- Sticker paper (optional)
- Cutting mat (optional)

INSTRUCTIONS **NOTE: Project assembly is intended for grown-ups only.**

1 Print out two copies of the frame. Allow to dry.

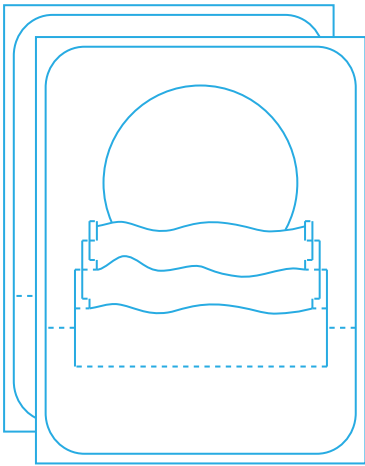

2 Print out Kwanzaa picture frame embellishments on sticker paper or regular paper. Allow to dry.

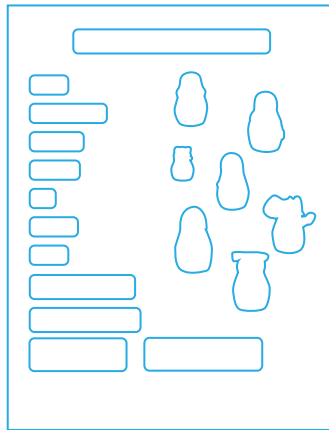

3 Using scissors or a cutting tool and cutting mat, cut along solid lines on each piece.

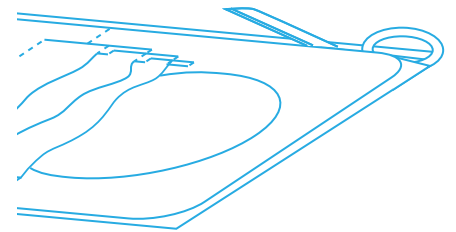

4 Using a ruler as a guide, run the backside of a butter knife firmly along dotted lines on all pieces.



5 Fold the Kwanzaa picture frame front at a 90-degree angle from the dotted horizontal line that divides the grass from the night sky. Help the folds that form the tri-colored 3-D mountain scene so that they appear as shown.

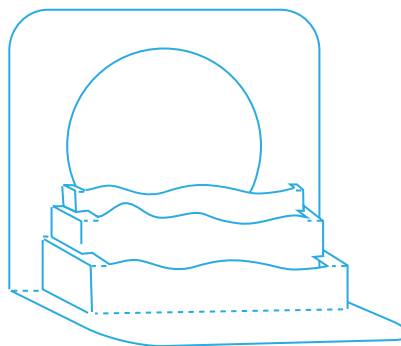

6 Glue a photograph behind the circular frame opening so that it is centered.

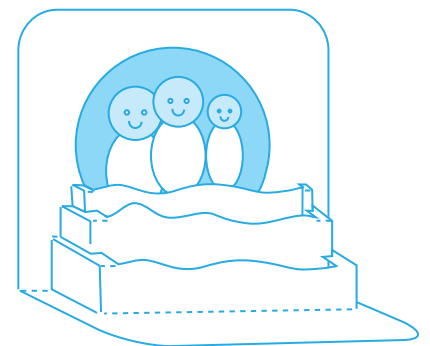

3-D Kwanzaa Picture Frame

7 Glue the second, non-cut frame copy to the back of your frame to help support it.

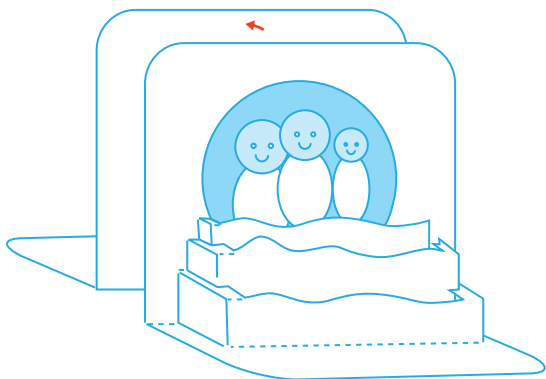

8 Glue or stick embellishments to the frame as you like.

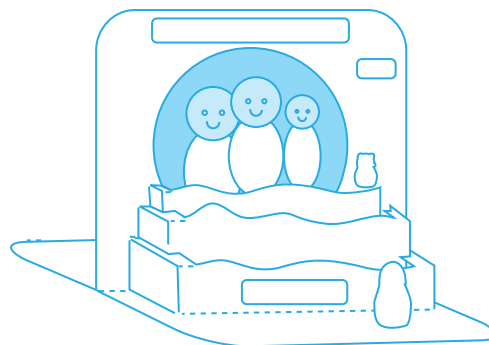

9 Allow to dry.

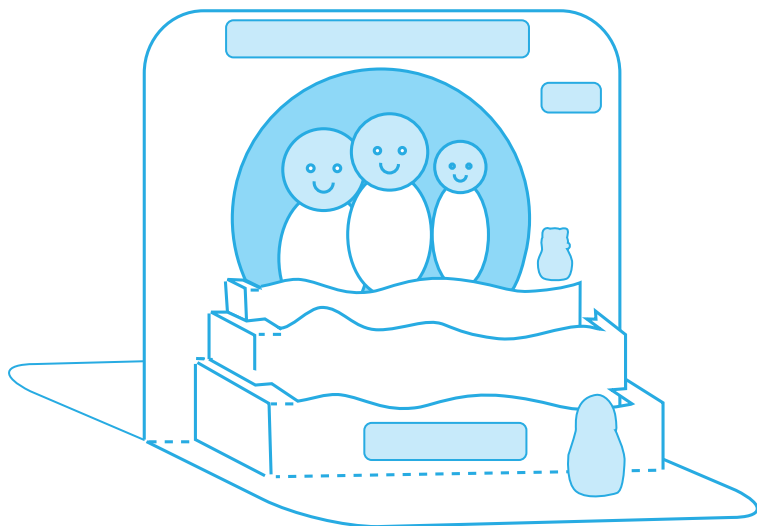

Disney Junior
ON DISNEY CHANNEL



DisneyJunior.com © Disney



HAPPY KWANZAA

UMOJA
UNITY

KUJICHAGULIA
SELF-DETERMINATION

UJIMA
WORK AND RESPONSIBILITY

UJAMAA
COOPERATIVE ECONOMICS

NIA
PURPOSE

KUUMBA
CREATIVITY

IMANI
FAITH



For the ancestors,
and their indomitable spirit.

For the elders,
from whom we can learn much.

For our youth,
who represent the promise
for tomorrow.

For our struggle,
and in remembrance of those
who have struggled on our behalf.



DisneyJunior.com